

Zero1

Electric Products and Access Control
Catalogue

presented by



m.marcus
architectural hardware

ISEO[®]
ULTIMATE ACCESS TECHNOLOGIES



ARGO
ISEO

Zero1

Electric Products and Access Control
Catalogue and Retail Price List with:
Argo System

Argo	p. 5
Smart Gateway	p. 8
Aries Smart 2.0	p. 11
MA1A Smart	p. 16
Libra LE60 Smart 2.0	p. 21
1NCA Smart Readers	p. 25
Smart Relay 2.0	p. 33
x1R Smart 2.0	p. 36



ISEO Electronic Solutions includes a wide range of electronic access control devices easy to install in order to meet every application requirement. You can choose different devices according to the door type and security level required:

- cable free off-line battery operated devices, such as Aries electronic trim set and Libra electronic cylinder;
- mechatronic cylinders with power source on the key only, such as F9000;
- wired devices such as Stylos credential readers, Atlas controllers and smart locks.

All the **ISEO electronic devices** can be combined to create the following access control system solutions:

ARGO

Argo is the ideal solution for residential or "light commercial" contexts (B&B, small companies, offices, shops, professional studios etc). You can use your smartphone as well as other devices, such as Apple Watch, fingerprint readers, PIN codes, keyfobs, cards for opening your doors. All you need is installing on your door, even without replacing them, an opening device of the Smart series (electronic locks, cylinders, trim sets, etc.). Thanks to Argo App, you decide who can enter your home, your office or the room of your accommodation facility. You can even set a time slot for each access. In combination with the Smart Gateway, you can manage the door lock from remote authorizing people to enter or reading events. That's why this is the perfect solution for private homes, B&B and small hotels. For example, you can allow your guests to open their room's door with their smartphone on a specific day and time, even if you are at home or at work.

V364

V364 is an advanced access control software for commercial applications allowing to manage both on-line and off-line doors for small- and medium- sized facilities. V364 is based on web server technology which allows the system up and running in minutes as it is not necessary to install any software.

V364 features a user-friendly interface allowing the management of your electronic access control system from computer with browser. V364 supports RFID technology and the mechatronic key F9000.

V364 is designed to easily scale and will be the core of your next level of facility integration by the system integrators of the ISEO Technology Partner program.

Argo Operating System

Argo is the ideal solution for managing residential or “light commercial” environments, like bed & breakfasts, shops, small offices, small businesses, and professional studios. By simply installing the Argo app on an iOS or Android smartphone, the user will have the possibility of managing, monitoring and opening all the doors upon which the Smart series ISEO devices are installed, with no need for any additional software or Internet connection: all this thanks to Bluetooth Smart technology, which allows the smartphone to communicate with the devices. Using the app installed on the smartphone, the user can organise the access permissions for up to 300 users, and view the last 1000 events detected on each door (entries, attempts at unauthorised entry, etc.).

In addition to smartphones, the doors can also be opened using Apple Watch from Series 4, ISEO USER cards and pre-existing Generic RFID cards (contactless credit cards, public transport tickets, access control cards, etc.), PIN codes and fingerprint readers. Furthermore in combination with the Smart Gateway, you can manage the door lock from remote authorizing people to enter or reading events.

Access management has never been so user-friendly: convenience and security have been combined in a completely new way to shape the future of access control.

ARGO means simplicity, access control and peace of mind.

Argo is the result of ISEO Group’s intensive R&D and commitment to innovation.

Key points

- EASY UPGRADE to an electronic access control system: the smart devices are interchangeable with existing mechanical locks.
- WIDE RANGE OF SMART DEVICES for any door type
- WIDE RANGE OF CREDENTIALS: Smartphone, Apple Watch, PIN Code, Fingerprint
- EASY MANAGEMENT of the list of users with access rights.
- QUICK CHANGE OF ACCESS RIGHTS if credentials are lost or stolen.
- QUICK REPORTING OF EVENTS to check who opened the door, and when.
- FREE ARGO APP and lock software (firmware) upgrades.
- ARGO APP Multilanguage
- NO ADDITIONAL SOFTWARE to install.
- NO INTERNET CONNECTION or cloud service registration needed for the Argo app.
- LOCK SOFTWARE (firmware) can be upgraded on site, without any need to disassemble the lock.
- POSSIBILITY OF REMOTE KEY DELIVERY with the free optional apps Argo Host and Argo Guest, and the remote key delivery Argo cloud service.
- REMOTE DOOR LOCK MANAGEMENT in combination with the Smart Gateway, and the ISEO Argo Account

Main functions

- Memorize up to 300 users credentials (cards, phones, Apple watch, PIN, Fingerprint);
- Records the last 1000 events;
- Operates with ISEO USER card or legacy generic cards (contactless credit cards, public transportation tickets, time attendance cards...);
- Administration with 3 levels MASTER cards set, keeping a safe system management even in case of lost MASTER cards;
- Login with authorized smartphone to manage doorlock
- Management for each user Start and end validity date
- Weekdays time tables access for each user management (up to 2 time tables per user);
- Door schedules (up to 2 time tables per user);
- Invitations and Remote Key Delivery;
- Remote opening;
- Quick visualization of battery status;
- Software upgradable on site via the Bluetooth Smart Ready phone.
- REMOTE management of users
- Remote events reading

Argo

Argo from Remote

The new generation of door lock smart devices featuring Bluetooth Smart 5.0, also called Bluetooth Low Energy 5.0 or BLE 5.0, combined with the Smart Gateway allows Argo from Remote: the Argo functionalities at anytime from anywhere in the world.

State of the art BLE 5.0 technology enables the door lock to simultaneous multiple connection: for example while one member of your family is opening with the smartphone the locks can connect to the a Smart Gateway and you can manage the door lock from remote adding users or reading events.



in order to operate Argo from Remote you need to have:

- 1) Argo 3.0 app
- 2) Smart devices featuring Bluetooth Smart 5.0
- 3) Smart Gateway
- 4) ISEO Argo Account

Argo Cards

Code

MASTER CARD SET.

3 cards (#1, #2, #3 the next Master automatically cancels the previous one).

Package: 3 cards , instructions.

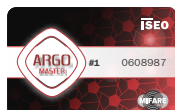

DESFire EV2

With ISEO logo

IS5E405309.3

USER CARDS



DESFire EV2

With ISEO logo and UID

IS5E405301



MIFARE CLASSIC

With ISEO logo and UID

IS5E402001.A

Blank on both sides

IS5E402011

Argo Keyfob and bracelet

USER KEYFOB



Leather-like Keyfob DESFire EV2

With ISEO logo and UID

IS5E425301



Black ABS Keyfob DESFire EV2

With ISEO logo and UID

IS5E415101



MIFARE CLASSIC

With ISEO logo and UID

ISKEYFOB1356MF1

USER BRACELET



Silicone Wristband DESFire EV2

With ISEO logo and UID - Not suitable to be used with x1R Smart Hidden RFID Reader

IS5E435101



Smart Gateway



Smart Gateway

The Smart Gateway connects the cloud (ISEO Argo account) to the door lock. It communicates with the cloud with data connection and towards the door lock with Bluetooth Smart 5.0. The Smart Gateway can manage all the door locks in its Bluetooth range (around 10 meters depending on environment conditions).

The Smart Gateway is available in two models:

- WIFI
- PoE Power over Ethernet

Main functions

- Converts data (WIFI or ethernet) to Bluetooth Smart 5.0
- Housing Desktop with wall fixing option
- Embedded Linux device
- Power supply: USB C + 5VDC input power
- Maximum Power Consumption 10W

Technical Features

CHARACTERISTICS	WIFI	PoE Power over Ethernet
Functionality	Converts from WIFI data to BLE 5.0 Dual Band WIFI at 2.4 GHz and 5 GHz	Converts from Ethernet data to BLE 5.0
Power Supply	Powered by USB C +5VDC input power 2A (10W) POWER SUPPLY NOT INCLUDED (ACCESSORY TO ORDER)	- PoE (Power over Ethernet) - Requires PoE Switch IEEE 802.3af up to 15,4W - Delivery of data and power over CAT5e/CAT6 ethernet cable. Maximum power consumption 10W - Optionally powered by USB C +5VDC input power 2A (10W) POWER SUPPLY NOT INCLUDED (ACCESSORY TO ORDER)
Size	LxDxH 125x40x85 mm	LxDxH 125x40x85 mm
Operating conditions	Operating Temperature: 0 C/+50 C Storage Temperature: -25 C/+75 C	Operating Temperature: 0 C/+50 C Storage Temperature: -25 C/+75 C
Installation	Desktop Wall Fixing option (accessory to order)	Desktop Wall Fixing option (accessory to order)
Connection ports	USB C female	USB C female Ethernet TCP/IP 10/100 baseT
Visual indicator	Signalling LEDs - Power (white): ON = Power Supply connected; - BLE (white): ON = BLE transmission in progress; - Network (white): ON = Gateway connected to Cloud; - Config (white): ON = Gateway to be configured; - Boot (red): ON = Gateway starting up.	Signalling LEDs - Power (white): ON = Power Supply connected; - BLE (white): ON = BLE transmission in progress; - Network (white): ON = Gateway connected to Cloud; - Config (white): ON = Gateway to be configured; - Boot (red): ON = Gateway starting up.
CPU, Memory, Operating System	ARM A7 based CPU module 512 MB RAM 8 GB Flash eMMC Non volatile Memory Operating System: embedded Linux	ARM A7 based CPU module 512 MB RAM 8 GB Flash eMMC Non volatile Memory Operating System: embedded Linux
Push buttons	Reset (reboot or factory mode status)	Reset (reboot or factory mode status)
OEM version	Available OEM version for Argo Integra- tors with SDK	Available OEM version for Argo Integra- tors with SDK

Smart Gateway

Code

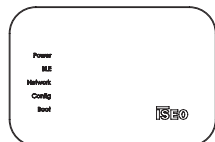

Smart Gateway WIFI

Dual Channel WIFI 2.4 Ghz and 5 GHz
POWER SUPPLY NOT INCLUDED (ACCESSORY TO ORDER)
Wall mount option (accessory to order)

IS5E075524

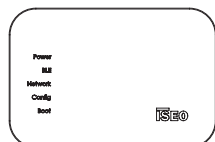
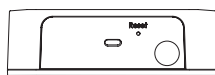

Smart Gateway PoE

Power over Ethernet
POWER SUPPLY NOT INCLUDED (ACCESSORY TO ORDER)
Wall mount option (accessory to order)

IS5E075514

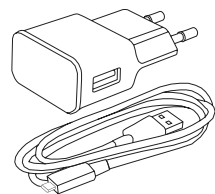
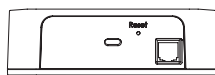

POWER SUPPLY

IN = 100-240V50-60Hz 0.50A
OUT = 5.0Vdc 2A (10W)
USB A to USB C 1.5 mt cable

IS0000A00155

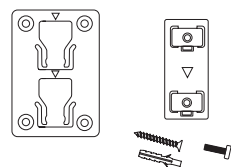

WALL FIXING BRACKETS KIT

nr. 1 Wall bracket
nr. 1 Gateway bracket
nr. 2 Screws
nr. 4 Wall plugs and screws

IS0000A00154



Aries Smart 2.0



Aries Smart 2.0

The installation flexibility and simplicity make it the perfect solution for community and residential access control (shopping malls, industries, public and private offices, schools and universities, hospitals and retired hostels, residences and hotels, etc.).

Key points

ARIES electronic trim set can be fit on most doors. It is conceived to be used also with the majority of mechanical locks, for the utmost installation flexibility.

The battery operation and cableless technology makes ARIES the perfect solution for access management, ensuring utmost flexibility and low installation costs both on new and existing doors.

Its **38 mm** narrow profile allows for a simple installation on any door (wooden, aluminium, metal, PVC and so on), together with locks with a backset of **only 25 mm**.

The nylon underplate allows to install ARIES electronic trim set (in combination with locks with backset minimum 40 mm) in replacement of old mechanical handles covering any holes on the door.

All electronic and mechanical devices are inside the trim set and fixing only requires 3 holes on the door - one for the handle follower and one for the two fixing screws. This ensures a rapid, simple and harmless installation even on existing doors.

Minimal and stylish, with several finishes, ARIES easily adapts to any type of environment.

Main functions

- Multistandard RFID Reader (ISO14443A/ISO14443B - 13,56MHz)
- SMART version with Bluetooth Smart 5.0.
- Wake up by RFID card detection or phone (patented).
- Energy-friendly, battery-operated device
- Permanently open mode (office mode) without no extra battery consumption.
- Battery charge status.
- Real Time Clock/Calendar.
- Handle movement detection.
- Emergency mechanical key detection.
- Privacy signal.
- Narrow profile (38 mm).
- Compatible with most mechanical lock.
- Quick and easy installation.
- Light and acoustic signals.
- On-site software upgrading.
- IP55 version for outdoor installation.



Aries Smart 2.0

Code

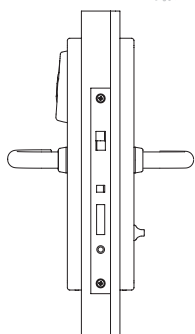
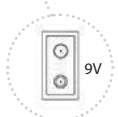
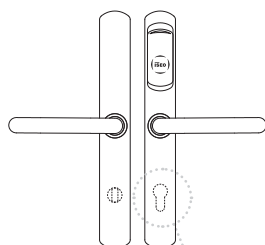

ELECTRONIC TRIM SET, ARGO SOFTWARE

Multistandard RFID Reader (ISO14443A/ISO14443B 13,56MHz).

Mechanical or electrical override.

Mechanical cylinder **override detection, only with ISEO R90 cylinder.**

Privacy device (optional).

Security U-shaped handle.

Package: 1 trim (pair), 2 batteries, 2 mm hex key, instruction manual.

NOTE: Handle follower and fixing screws set, mechanical override cylinder and mechanical lock not included.

Aries Smart – 00mm No Cyl – EN179 / IP54 – No Privacy – BT5.0 Argo -Inox
 Aries Smart – 72m m Centre – EN179 / IP54 – No Privacy – BT5.0 Argo -Inox
 Aries Smart – 85m m Centre – EN179 / IP54 – No Privacy – BT5.0 Argo -Inox
 Aries Smart – 92m m Centre – EN179 / IP54 – No Privacy – BT5.0 Argo -Inox

IS00E11141552
IS00E15141552
IS00E12141552
IS00E13141552

Aries Smart – 00mm NoCyl – EN1125 / IP54 – No Privacy – BT5.0 Argo -Inox
 Aries Smart – 72m m Centre – EN1125 / IP54 – No Privacy – BT5.0 Argo -Inox
 Aries Smart – 85m m Centre – EN1125 / IP54 – No Privacy – BT5.0 Argo -Inox
 Aries Smart – 92m m Centre – EN1125 / IP54 – No Privacy – BT5.0 Argo -Inox

IS00E11241552
IS00E15241552
IS00E12241552
IS00E13241552

application example

Aries Smart – 00mm No Cyl – EN179 / IP54 – Privacy – BT5.0 Argo -Inox
 Aries Smart – 72m m Centre – EN179 / IP54 – Privacy – BT5.0 Argo -Inox
 Aries Smart – 85m m Centre – EN179 / IP54 – Privacy – BT5.0 Argo -Inox
 Aries Smart – 92m m Centre – EN179 / IP54 – Privacy – BT5.0 Argo -Inox

IS00E11131552
IS00E15131552
IS00E12131552
IS00E13131552

Aries Smart – EI Emergency – EN179 / IP54 – No Privacy – BT5.0 Argo -Inox

IS00E11121552

Aries Smart – EI Emergency – EN1125 / IP54 – No Privacy – BT5.0 Argo -Inox

IS00E11221552

Aries Smart – EI Emergency – EN179 / IP54 – Privacy – BT5.0 Argo -Inox

IS00E11111552



Aries Smart 2.0 for panic devices

Code

ELECTRONIC TRIM SET FOR PANIC DEVICES, ARGO SOFTWARE

Multistandard RFID Reader (ISO14443A/ISO14443B 13,56MHz).

Mechanical or electrical override.

Mechanical cylinder **override detection (hidden), only with ISEO R90 cylinder.**

Security U-shaped handle.

EN1125 certification in combination with specific panic devices.

Package: 1 trim, 1 battery holder, 2 batteries, 2 mm hex key, instruction manual.

NOTE: Handle follower and fixing screws set, adaptes kit plate, mechanical override cylinder and mechanical lock not included.

Aries Smart – 00mm No Cyl – EN1125 / IP54 – No Privacy – BT5.0 Argo -Inox

Aries Smart – 72 mm Centre – EN1125 / IP54 – No Privacy – BT5.0 Argo -Inox

Aries Smart – 85 mm Centre – EN1125 / IP54 – No Privacy – BT5.0 Argo -Inox

Aries Smart – 92 mm Centre – EN1125 / IP54 – No Privacy – BT5.0 Argo -Inox

IS00E11241552

IS00E15241552

IS00E12241552

IS00E13241552

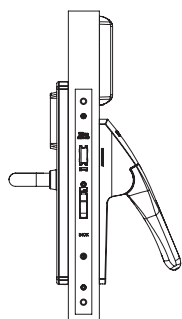
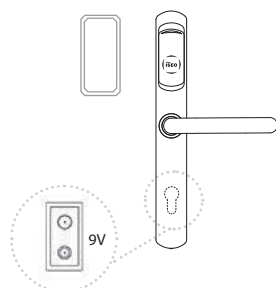

application example



ADAPTER PLATE KIT

For panic devices installation with

series 214* panic lock case (DIN 72 mm center distance)

For panic devices, 9 mm spindle and fixing screws for doors up to 85 mm thick

IS201E915570A

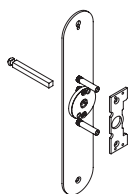

ADAPTER PLATE KIT

For RIM panic devices Idea Push installation

Package: plates, fixing screws, accessories.

Adapter plate kit For panic devices intallation with series 214* panic lock case

IS529E080054

Aries Smart 2.0

Code

SCREWS AND HANDLE FOLLOWER KIT

2 screws M5 with threadlocking. Package: 2 screws, 1 handle follower

NOTE: Select the right kit depending on door thickness.

8 mm Spindle

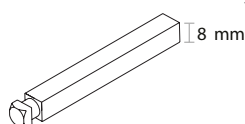

Door thickness from 40 to 55 mm
Door thickness from 55 to 70 mm
Door thickness from 70 to 85 mm

IS201E004055A
IS201E005570A
IS201E007085A

9 mm Spindle (for fire doors)

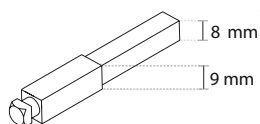

Door thickness from 40 to 55 mm
Door thickness from 55 to 70 mm
Door thickness from 70 to 85 mm

IS201E094055A
IS201E095570A
IS201E097085A

ADAPTER FOR HANDLE FOLLOWER

8 to 9 mm adapter

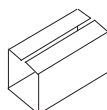

Adapter for handle follower

IS5060000900092

PLASTIC UNDERPLATE

Black plastic underplate to cover up eventually visible key holes

Dimensions: H=312 mm, L=70 mm

Package: 1 underplate

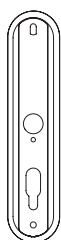

Black plastic underplate - Dimensions: H=312 mm, L=70 mm

IS529E00000

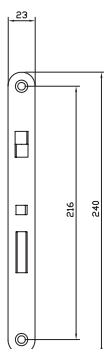
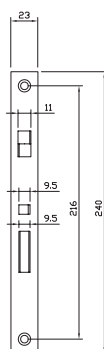
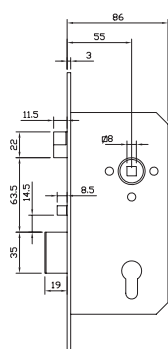

AUTOMATIC MECHANICAL LOCK

Mortise lock, **automatic deadbolt function** (18 mm extension)

Panic exit function, splitted latchbolt, equipped with devices against forced entry (reversible).

Backset: 55 mm, center distance: 85 mm, 8 mm handle follower

Chrome plated, squared/rounded frontplate

Package: 1 lock, 1 striking plate.

Squared frontplate

IS207553.Z

Rounded frontplate

IS217553.Z

BATTERY

High current lithium battery

Size AA, 3.6 Vcc

High current lithium battery - Size AA, 3.6 Vcc

IS58200000E0360

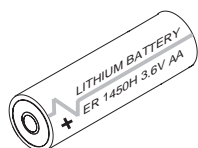

MA1A Smart





MA1A Smart

The MA1A Connected Smart Handle from ISEO is a highly versatile Smart Lock that is compact and easy to use. It features a sleek, contemporary design that is both stylish and functional, and can be installed quickly and effortlessly. It is the perfect retrofit solution for internal doors, as it is compatible with all DIN-type mechanical locks. For residential, light commercial, and hospitality settings, it's crucial to have an access control system that is user-friendly, easy to install, and compatible with existing doors. The MA1A Connected Smart Handle, in conjunction with the Argo software, is the perfect solution, offering simplicity and intuitive operation, adaptability to all types of doors, and easy maintenance and service.

Key points

Made in Italy cutting-edge design: simple, stylish, minimal and elegant.

Compact design, small dimensions.

No wiring, no door drilling, ease and speed of installation

Battery powered

Compatible to all European DIN locks

Ideal solution for internal doors (IP54)

RFID and Bluetooth communication channels

Certified according to EN16867:2020, EN1634-1, CE, RED, UKCA

Compatible to all ISEO's software solutions: Argo, V364, LSA, Sofia Luckey

Safe-Touch antibacterial protection for MA1A handles (option on request)

Main functions

- Multistandard RFID Reader (ISO14443A/ISO14443B - 13,56MHz)
- Bluetooth Smart 5.0.
- Wake up by RFID card detection or phone.
- Energy-friendly, battery-operated device
- Permanently open mode (office mode) without no extra battery consumption.
- Battery charge status.
- Real Time Clock/Calendar.
- Compatible to all European DIN locks keeping the existing mechanical cylinder
- Quick and easy installation.
- Light and acoustic signals.
- On-site software upgrading.
- IP grading IP54: protected from limited dust ingress and water spray from any direction.

MA1A Smart



MA1A Connected Smart Handle

Argo software

Multistandard RFID Reader 13,56MHz

Bluetooth Smart 5.0

Battery powered

Black color

Package includes: 1 MA1A, 3 AAA alkaline batteries, 1 Torx key, Anti-tilt kit

NOTE: handle set, lock, spindle and fixing screws not included,
to be ordered separately

CODE	DESCRIPTION
IS00E40201555	MA1A Connected Smart Handle

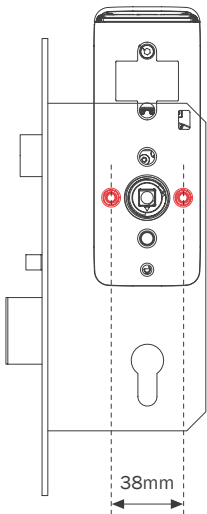

Handle Set

CODE

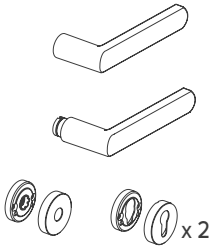

YUMA

MA1A Handle Set

Package: 1 MA1A external handle, 1 Internal handle, 1 Internal handle fixing plate with reinforcing spring and cover, 2 Internal and external cylinder escutcheons with covers.

Zamak Alloy – Matte Black RAL 9005

IS00.329.005

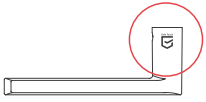

WITH SAFE TOUCH ANTIBACTERIAL PROTECTION

Safe Touch treatment applied to external and internal handles.

IS00.329.005A

Zamak Alloy – Satin Chrome

IS00.329.00Y



WITH SAFE TOUCH ANTIBACTERIAL PROTECTION

Safe Touch treatment applied to external and internal handles.

IS00.329.00YA

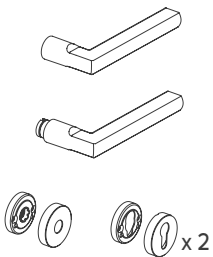

URACAN

MA1A Handle Set

Package: 1 MA1A external handle, 1 Internal handle, 1 Internal handle fixing plate with reinforcing spring and cover, 2 Internal and external cylinder escutcheons with covers.

Stainless steel – Matte Black RAL 9005

IS00.431.005

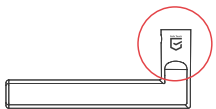

WITH SAFE TOUCH ANTIBACTERIAL PROTECTION

Safe Touch treatment applied to external and internal handles.

IS00.431.005A

Satin Stainless steel

IS00.431.002



WITH SAFE TOUCH ANTIBACTERIAL PROTECTION

Safe Touch treatment applied to external and internal handles.

IS00.431.002A

Spindle and screws kit

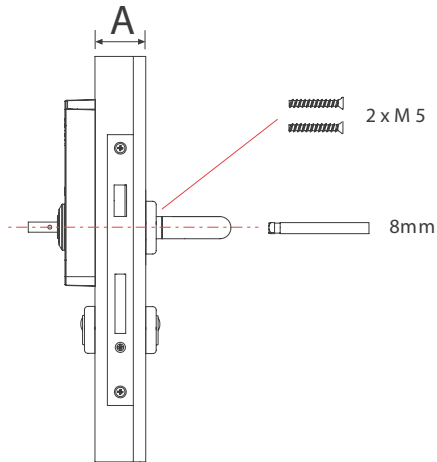

Spindle and screws length related to door thickness (A)
 Package includes: 1 square spindle, 2 M5 fixing screws with thread-locking.
 NOTE: select the right kit depending on door thickness.

8 mm square spindle * and 2xM5 screws kit

	CODE
Door thickness from 40 to 50 mm	IS201E004050A
Door thickness from 50 to 60 mm	IS201E005060A
Door thickness from 60 to 70 mm	IS201E006070A
Door thickness from 70 to 80 mm	IS201E007080A
Door thickness from 80 to max 125 mm (to be cut)	IS201E008010A

* For 7 and 9mm square spindles, refer to Aries screws and handle follower kit chapter.



Libra LE60 Smart 2.1





Libra LE60 Smart 2.1 Electronic modular cylinder

Thanks to the quick and easy installation, the electronic modular cylinder LIBRA is the ideal and universal solution both for the replacement of mechanical European profile cylinders and for installation on new doors. Together with ARIES electronic trim set, LIBRA represents a complete range fulfilling any need for access control management both for community and residential environment (shopping malls, industries, public and private offices, schools and universities, hospitals and retirement homes, residences and hotels, etc.). Libra LE60 Smart 2.1 embeds a new micro-processor keeping the same functionalities of Libra LE60 Smart 2.0.

Key points

The electronic modular cylinder LIBRA can be installed in most of the doors equipped with an European profile cylinder hole (EN1303).

It is battery operated, so it doesn't require any electrical external cabling. The result is the best flexibility and cost effectiveness of installation, both in new doors and in retrofitting.

The high modularity of the cylinder, obtained thanks to its patented design, drastically reduces the number of components required to build all the versions and measures necessary to cover the wide range of potential installations, with consequent reduction of components stocks, better flexibility and fast reaction to customer requests.

The unique and innovative design, combined with the finishes and colors available, allows the smooth integration in any architectural contexts.

Main functions

- Multistandard RFID Reader (ISO14443A/ISO14443B).
- Bluetooth Smart 5.0
- Wake up by RFID card or phone detection (patented) or Real Time Clock.
- Low consumption battery operated.
- Permanently open mode (passage mode) without extra battery consumption.
- Batteries voltage monitoring.
- Real Time Clock/Calendar.
- Compact size and innovative design.
- Compatible with all the mechanical locks equipped with an European profile cylinder hole (EN1303, DIN 18252).
- Very easy and quick installation thanks to the modular design.
- All versions are IP66/IP67/IP68/IP69 grading.
- Heavy Duty version with drilling protection on the opening mechanism.
- Optical and acoustic signalling.
- On-site software upgrading.
- 4 finishes.



..... The Libra Smart electronic cylinder was selected for the 2013 ADI Design Index, and was given a Mention of Honour at the 23rd edition of the Compasso d'Oro award. It was also among the finalists at the 2014 IFSEC Security & Fire Excellence Awards, and was nominated for the 2015 German Design Awards.

Libra LE60 Smart 2.1 - Standard

Code

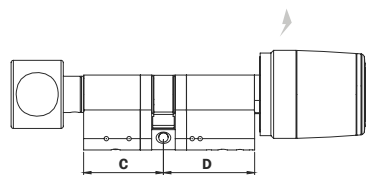

ELECTRONIC CYLINDER WITH RFID READER AND "STANDARD" MECHANICAL KNOB, ARGO SOFTWARE
Multistandard RFID Reader (ISO14443A/ISO14443B 13,56MHz) on outside
"Standard" mechanical knob on internal side. Maximal body length 260 mm.
European profile and DIN cam. Available in 4 finishes.
IP protection degree IP66/IP67/IP68/IP69 for all versions. Available Heavy Duty version with drilling protection.
Available Panic function version.

* Other sizes are available and are priced as follows:

MECHANICAL/ ELECTRICAL CYLINDER 85 -100MM OVERALL LENGTH

MECHANICAL/ ELECTRICAL CYLINDERS 105 -120MM OVERALL LENGTH

LIBRA S Std -M/E - 30/30 R1S -Inox/Black Standard BT5.0	IS8MK1830302565
LIBRA S Std -M/E - 35/35 R1S -Inox/Black Standard BT5.0	IS8MK2835352565
LIBRA S Std -M/E - 40/40 R1S -Inox/Black Standard BT5.0	IS8MK2840402565
LIBRA S Std -M/E - 30/30 R1S -Polished Brass/Black Standard BT5.0	IS8MK283030L565
LIBRA S Std -M/E - 35/35 R1S -Polished Brass/Black Standard BT5.0	IS8MK283535L565
LIBRA S Std -M/E - 40/40 R1S -Polished Brass/Black Standard BT5.0	IS8MK284040L565
LIBRA S Std -M/E - 30/30 R1S -Polished Chrome/White Standard BT5.0	IS8MK283030K465
LIBRA S Std -M/E - 35/35 R1S -Polished Chrome/White Standard BT5.0	IS8MK283535K465
LIBRA S Std -M/E - 40/40 R1S -Polished Chrome/White Standard BT5.0	IS8MK284040K465

Libra LE60 Smart 2.1 - Double

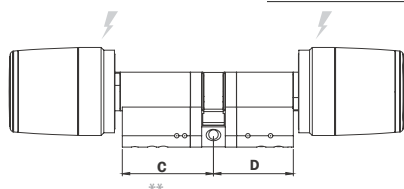

ELECTRONIC CYLINDER WITH DOUBLE RFID READER, ARGO SOFTWARE
Multistandard RFID Readers (ISO14443A/ISO14443B 13,56MHz) on external side and internal side.
Maximal body length 180 mm. European profile and DIN cam.
Available in 4 finishes.
IP protection degree IP66/IP67/IP68/IP69 for all versions. Available Heavy Duty version with drilling protection.
Package: 1 cylinder, 2 battery, cylinder fixing screw, 2 mm hex key, instruction sheet.

* Other sizes are available and are priced as follows:

MECHANICAL/ ELECTRICAL CYLINDER 85 -100MM OVERALL LENGTH

MECHANICAL/ ELECTRICAL CYLINDERS 105 -120MM OVERALL LENGTH

LIBRA S Prem - E/E - 30/30 R1S -Inox/Black Standard BT5.0	IS8MK2E30302565
LIBRA S Prem - E/E - 35/35 R1S -Inox/Black Standard BT5.0	IS8MK2E35352565
LIBRA S Prem - E/E - 40/40 R1S -Inox/Black Standard BT5.0	IS8MK2E40402565
LIBRA S Prem - E/E - 30/30 R1S -Polished Brass/Black Standard BT5.0	IS8MK2E3030L565
LIBRA S Prem - E/E - 35/35 R1S -Polished Brass/Black Standard BT5.0	IS8MK2E3535L565
LIBRA S Prem - E/E - 40/40 R1S -Polished Brass/Black Standard BT5.0	IS8MK2E4040L565
LIBRA S Prem - E/E - 30/30 R1S -Polished Chrome/White Standard BT5.0	IS8MK2E3030K465
LIBRA S Prem - E/E - 35/35 R1S -Polished Chrome/White Standard BT5.0	IS8MK2E3535K465
LIBRA S Prem - E/E - 40/40 R1S -Polished Chrome/White Standard BT5.0	IS8MK2E4040K465

Libra LE60 Smart 2.1 - Half

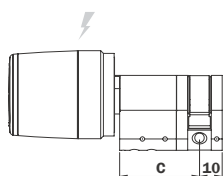

ELECTRONIC HALF CYLINDER WITH RFID READER, ARGO SOFTWARE
Multistandard RFID Reader (ISO14443A/ISO14443B 13,56MHz).
Maximal body length 190 mm. European profile and DIN cam.
Available in 3 finishes.
IP protection degree IP66/IP67/IP68/IP69 for all versions. Available Heavy Duty version with drilling protection.
Package: 1 cylinder, 1 battery, cylinder fixing screw, 2 mm hex key, instruction sheet

LIBRA S Half - E - 30/10 R1S -Inox/Black Standard BT5.0	IS8MK2030102565
LIBRA S Half - E - 35/10 R1S -Inox/Black Standard BT5.0	IS8MK2035102565
LIBRA S Half - E - 40/10 R1S -Inox/Black Standard BT5.0	IS8MK2040102565
LIBRA S Half - E - 30/10 R1S -Polished Brass/Black Standard BT5.0	IS8MK203010L565
LIBRA S Half - E - 35/10 R1S -Polished Brass/Black Standard BT5.0	IS8MK203510L565
LIBRA S Half - E - 40/10 R1S -Polished Brass/Black Standard BT5.0	IS8MK204010L565
LIBRA S Half - E - 30/10 R1S -PC/White Standard BT5.0	IS8MK203010K465
LIBRA S Half - E - 35/10 R1S -PC/White Standard BT5.0	IS8MK203510K465
LIBRA S Half - E - 40/10 R1S -PC/White Standard BT5.0	IS8MK204010K465

*Other sizes are available and are priced as follows:

ELECTRICAL/ ELECTRICAL CYLINDER 85-100MM OVERALL LENGTH
ELECTRICAL/ ELECTRICAL CYLINDERS 105-120MM OVERALL LENGTH

Libra LE60 Smart 2.1

Code



“PREMIUM” KNOB COVER

Suitable both for RFID reader knob and
“Premium” mechanical knob.

Premium knob cover, Inox/Black
Premium knob cover, Polished Brass/Black
Premium knob cover, Polished Chrome/White

IS0444325
IS04443L5
IS04443K4

“STANDARD” MECHANICAL KNOB

Internal mechanical knob.

Package: 1 knob, 1 fixing screw.

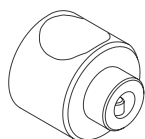

Standard mechanical knob, Inox
Standard mechanical knob, Polished Chrome
Standard mechanical knob, Polished Brass

IS044232
IS04423K
IS04423L

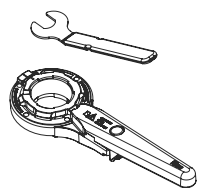

ASSEMBLY/DISASSEMBLY TOOLING KIT FOR ELECTRONIC KNOB COVER

Necessary for battery replacement.

New design with improved performances and auto assembly force detection.

NOT suitable for backset <45 mm.

Package: 1 wrench, 1 plier, instruction sheet

PLEASE NOTE: tool set not included with the Libra LE60. To order separately.

IS003302

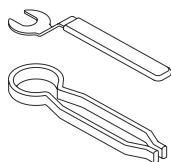

ASSEMBLY/DISASSEMBLY TOOLING KIT FOR ELECTRONIC KNOB COVER

Necessary for battery replacement.

Also suitable for backset <45 mm.

Package: 1 wrench, 1 plier, instruction sheet

PLEASE NOTE: tool set not included with the Libra LE60. To order separately.

IS003092

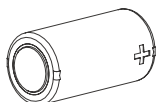

BATTERY (compatible only with Libra LE60)
Lithium battery FDK CR17335EF 3V 1400 mAh

IS0033960

1NCA Smart Readers





1NCA Smart Readers

1NCA Smart readers is the newest range of credential readers for Argo featuring a sleek, contemporary design suitable for outdoor installations (IP66).

1NCA Smart readers are available in the following range:

1NCA Mullion Smart lockbus

Capable to read RFID credentials and connect to Argo smartphone with BLE 5. Suitable as a replacement of Stylos Smart 2.0 to couple with the ELECTRIC LOCK ACTUATOR.

1NCA Mullion Smart Relay

Capable to read RFID credentials and connect to Argo smartphone with BLE 5. Featuring a built-in relay to control any access control device for an easy and quick installation.

1NCA Mullion Smart Keyboard lockbus

Featuring a numeric keyboard, it is capable to read RFID credentials and connect to Argo smartphone with BLE 5. Suitable as a replacement of Stylos Smart 2.0 to couple with the ELECTRIC LOCK ACTUATOR.

1NCA Mullion Smart Keyboard Relay

Capable to read RFID credentials and connect to Argo smartphone with BLE 5. Featuring a built-in relay to control any access control device for an easy and quick installation.

Key points

Installation on mullion frame

Suitable for outdoor installations (IP66)

Lockbus version as replacement of Stylos Smart 2.0

Relay version with built in relay or an easy and quick installation.

Memorizes up to 300 users (cards or phones).

Stores the last 1000 events.

Software upgradable on site via Bluetooth Smart Ready phone.

1NCA Smart Readers

Models	1NCA Mullion Smart lockbus	1NCA Mullion Smart Relay	1NCA Mullion Smart Keyboard lockbus	1NCA Mullion Smart Keyboard Relay
Product code	5E152315	5E152415	5E152325	5E152425
Keyboard	No	No	12 capacitive keys	
Reader data connection	Lockbus	No	Lockbus	No
Relay	No	-N.O. (normally open) contact -Output power relay 30Vac/dc - 2A -Estimated operation's cycles: 100.000	No	-N.O. (normally open) contact -Output power relay 30Vac/dc - 2A -Estimated operation's cycles: 100.000
Cable Wires colors and signals	WHITE = Vdc+ BROWN=Vdc- (GND) YELLOW = Lockbus GREEN = not used	WHITE = Vdc+ BROWN =Vdc- (GND) YELLOW =Relay N.O. GREEN= Relay COM	WHITE = Vdc+ BROWN=Vdc- (GND) YELLOW = Lockbus GREEN = not used	WHITE = Vdc+ BROWN = Vdc- (GND) YELLOW = Relay N.O. GREEN = Relay COM
Housing	To be fixed to the wall by the multi-holes fixing bracket			
Reader Dimensions in mm	LxWxH 146 x 48 x 26			
Spacer dimensions	LxWxH 146 x 48 x 10			
Power Supply	9÷24 Vdc			
Max Power consumption	1W			
Automatic low power mode	max 0,4 mW			
Visual indicator	Tri-color LED (green, red, blu)			
Audible signal	Multifrequencies buzzer			
Connection Cable	5 meter shielded cable AWG22 - Polyethylene Gray - Cable external diameter 7,6mm - 2 twisted pair conductors 2x2x0,34mmq - 250V			
Battery	Backup RTC (reat time clock) internal battery CR2032 3V Lithium coin battery			
Tamper	Detects if the 1NCA Mullion is removed from the wall - Tamper on back of housing (Tamper will be managed in future software releases)			
Communication Interfaces	- Bluetooth 5.0 - Frequency 2,40 - 2,4835 GHz Maximum power: < 10 mW - RFID reader frequency 13,553 - 13,567 MHz, maximum magnetic field: < 40 µA/m (measured at 10m at the maximum power capacity). Compatible to: • ISO/IEC 14443 Type A and Type B cards • MIFARE Classic & DESFire (EV1, EV2, EV3) • ISEO Cards & Keyfobs (min.20mm antenna diam.)			
IP Grade	IP66			
Working Temperature	-20°C/+60°C			
Storage Temperature	-20°C/+70°C			
Humidity Relative	Max. 95% with no condensing			
Certifications	Compliance to RED, European and UK directives concerning radio equipment regulations			
Software	Software upgradable on site via Bluetooth Smart Ready phone.			

Lockbus

- 3 wires multipoint serial bus for power and data
- Self-adjusting power supply from 9Vdc to 24Vdc (recommended voltage 24 Vdc)
- Secure device authentication among readers and actuators and encrypted data transmission
- Max cable length 100 mt

1NCA Smart Readers

Code

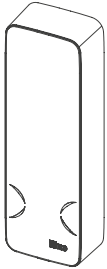

1NCA Mullion Smart Lockbus

IS5E152315

CREDENTIAL READER with lockbus connection.

RFID contactless multistandard. ISO14443/A - ISO14443/B.

Lockbus interface.

9-24Vdc Power Supply.

Wall mounting.

Package: 1 reader, 1 fixing bracket, Torx T8 key, 1 x Fixing bracket Torx screw (M2,5x5), instruction manual, 2 x Screws (3,5x25 countersunk head) and wall plugs (5x25), SPACER WITH SCREWS (cod. 0000IS00354)

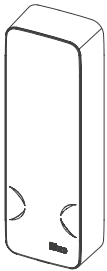

1NCA Mullion Smart Relay

IS5E152415

CREDENTIAL READER with built in RELAY

RFID contactless multistandard. ISO14443/A - ISO14443/B.

9-24Vdc Power Supply.

Wall mounting.

Package: 1 reader, 1 fixing bracket, Torx T8 key, 1 x Fixing bracket Torx screw (M2,5x5), instruction manual, 2 x Screws (3,5x25 countersunk head) and wall plugs (5x25)

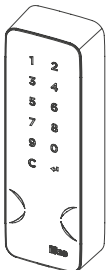

1NCA Mullion Smart Keyboard Lockbus

IS5E152325

CREDENTIAL READER with KEYPAD with Lockbus connection.

RFID contactless multistandard. ISO14443/A - ISO14443/B.

Lockbus interface.

9-24Vdc Power Supply.

Wall mounting.

Package: 1 reader, 1 fixing bracket, Torx T8 key, 1 x Fixing bracket Torx screw (M2,5x5), instruction manual, 2 x Screws (3,5x25 countersunk head) and wall plugs (5x25), SPACER WITH SCREWS (cod. 0000IS00354)

(available from Q4 2023)

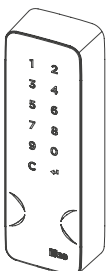

1NCA Mullion Smart Keyboard Relay

IS5E152425

CREDENTIAL READER WITH KEYPAD with built in RELAY.

RFID contactless multistandard. ISO14443/A - ISO14443/B.

9-24Vdc Power Supply.

Wall mounting.

Package: 1 reader, 1 fixing bracket, Torx T8 key, 1 x Fixing bracket Torx screw (M2,5x5), instruction manual, 2 x Screws (3,5x25 countersunk head) and wall plugs (5x25).

(available from Q4 2023)

1NCA Mullion Smart Accessories

Code

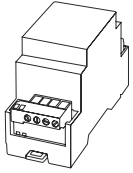

Electric lock actuator

1 relay + 1 booster.
3 inputs (1 digital, 1 analog, 1 digital/ analog)
Lockbus interface.
8-30Vdc Power Supply
DIN35 rail mounting.
Package: 1 actuator, instruction manual.

IS5E2501

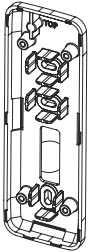

Spacer with screws

2 x Screws (3,5x25 flat-head)
4 x Screws (3x8)

IS0000IS00354

1NCA Smart Readers

1NCA Cable Free Smart

The **1NCA Cable Free Smart** readers are battery operated and can be coupled to any Argo Smart locking device via Bluetooth Smart, in order to increase its credential capabilities.

The **1NCA Cable Free Smart** readers are available in the following models:

- **The 1NCA Cable Free Smart**
capable to read RFID credentials (card, tag, keyfob, wristband)
- **1NCA Cable Free Smart Keyboard**
featuring a numeric keyboard, it is capable to read RFID credentials.
- **1NCA Cable Free Smart Finger**
featuring a fingerprint reader and a numeric keyboard, it is capable to read RFID credentials.

Key points

- Installation without any cabling
- Suitable for outdoor installations (IP66)
- To couple to any Argo Smart Locking device
- Software upgradable on site via Bluetooth Smart Ready phone

1NCA Cable Free

Models	1NCA Cable Free RFID	1NCA Cable Free Keyboard	1NCA Cable Free Finger
Product code	5E1511155	5E1511255	5E1511355
Keyboard	No	12 capacitive keys	12 capacitive keys
Finger reader	No	No	Yes
Reader data connection	BLE 5 to any Argo smart locking devices		
Relay	No		
Cable Wires colors and signals	Cable Free		
Housing	To be fixed to the wall by the multi-holes fixing bracket		
Reader Dimensions in mm	LxWxH 82 x 82 x 26		LxWxH 120 x 82 x 35
Power Supply	4 Alkaline AA batteries		
Max Power consumption	1W		
Automatic low power mode	max 0,4 mW		
Visual indicator	Tri-color LED (green, red, blu)		
Audible signal	Multifrequencies buzzer		
Connection Cable	Cable Free		
Battery	No Backup internal battery		
Tamper	No		
Communication Interfaces	- Bluetooth 5.0 - Frequency 2,40 - 2,4835 GHz Maximum power: < 10 mW - RFID reader frequency 13,553 - 13,567 MHz, maximum magnetic field: < 40 µA/m (measured at 10m at the maximum power capacity). Compatible to: <ul style="list-style-type: none"> • ISO/IEC 14443 Type A and Type B cards • MIFARE Classic & DESFire (EV1, EV2, EV3) • ISEO Cards & Keyfobs (min.20mm antenna diam.) 		
IP Grade	IP66		
Working Temperature	-20°C/+60°C		
Storage Temperature	-20°C/+70°C		
Humidity Relative	Max. 95% with no condensing		
Certifications	Compliance to RED, European and UK directives concerning radio equipment regulations		
Software	Software upgradable on site via Bluetooth Smart Ready phone.		

1NCA Cable Free

Code



1NCA Cable Free Smart RFID

IS5E1511155

CREDENTIAL READER for RFID credentials with BLE5 connection to Argo Smart locking devices.

RFID contactless multistandard. ISO14443/A - ISO14443/B.

Battery powered (4 x Alkaline batteries 1,5V type AA)

Wall mounting.

Package: 1 reader, 4 Alkaline AA batteries, 1 fixing bracket, Torx T8 key, 1 x Fixing bracket Torx screw (M2,5x5), instruction manual, 2 x Screws (3,5x25 countersunk head) and wall plugs (5x25).



1NCA Cable Free Smart Keyboard

IS5E1511255

CREDENTIAL READER for RFID credentials with KEYPAD and BLE5 connection to Argo Smart locking devices

RFID contactless multistandard. ISO14443/A - ISO14443/B.

Battery powered (4 x Alkaline batteries 1,5V type AA).

Wall mounting.

Package: 1 reader, 4 Alkaline AA batteries, 1 fixing bracket, Torx T8 key, 1 x Fixing bracket Torx screw (M2,5x5), instruction manual, 2 x Screws (3,5x25 countersunk head) and wall plugs (5x25).

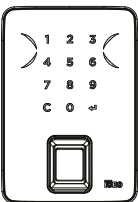

1NCA Cable Free Smart Finger

IS5E1511355

FINGER reader and BLE5 connection to Argo Smart locking devices.

RFID contactless multistandard. ISO14443/A - ISO14443/B.

Battery powered (4 x Alkaline batteries 1,5V type AA).

Wall mounting.

Package: 1 reader, 4 Alkaline AA batteries, 1 fixing bracket, Torx T8 key, 1 x Fixing bracket Torx screw (M2,5x5), instruction manual, 2 x Screws (3,5x25 countersunk head) and wall plugs (5x25).

Smart Relay 2.0



Smart Relay 2.0

The Smart Relay allows to open electric locks, motorized gate or any electrical actuator which can be activated closing a contact. The Smart Relay closes a contact if a smartphone is registered in the device.

It comes in 2 different models to be selected according to installations requirements:

1. Smart Relay with built in Bluetooth Smart 5.0: the Bluetooth Smart antenna is embedded in the Smart Relay box.
2. Smart Relay with Remote Bluetooth Smart 5.0: the Bluetooth Smart can be positioned at a distance of 3 meters from the unit.

Functions

RELAY

The Relay allows to control electric devices. It is a NO (Normally Open) contact up to 5 Ampere current.

MASTER

The Master switch allows to enter in Programming mode. This is required the first time from factory mode. The Master microswitch can be disabled after enrolling, with login enabled, the first smartphone in the users list. Then the smartphone can login without Master and prepare some invitations to login with additional smartphones.

REX (REQUEST TO EXIT)

REX (REquest to eXit) is an Opto-insulated input to open the relay with a button distant up to 100 meters.

INPUT

the cable (max length 25 meters) can be configured with Argo App as one of the following:

- Door Status.
- Second REX (REquest to eXit).
- Privacy ON.
- Disabled.

OUTPUT

(relay 1A) can be configured with the Argo App as one of the following:

- Privacy.
- Standard users blocked.
- Passage mode active (office mode).
- Door status.
- Buzzer.
- Green LED or Red LED of Argo devices.
- Lithium battery for Real Time clock Low.
- MASTER mode.
- Alarm for Power Supply low.
- Activates in sequece after RELAY opens eventually controlling the INPUT configured as door status.
- Disabled.

The OUTPUT relay is a signal relay (1A) and can be also configured as NO (default) or NC by a jumper under the cover enclosure.

Smart Relay 2.0

Code

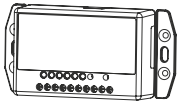

BUILT IN BLUETOOTH SMART 5.0

Power supply 10-30 VDC 12-24 VAC

2 INPUTS: REX (Request to Exit) and Configurable INPUT

2 OUTPUTS: RELAY 5 A and Configurable Signal Relay 1 A

Package: 1 Smart Relay, 1 Plastic pin to setup Programming Mode, 1 DIN rail mounting clip with screws, 1 Installation guide (EN/IT)

BUILT IN BLUETOOTH SMART 5.0

IS5E065501

EXTERNAL BLUETOOTH SMART 5.0 (MAX 3 METERS)

Power supply 10-30 VDC 12-24 VAC

2 INPUTS: REX (Request to Exit) and Configurable INPUT

2 OUTPUTS: RELAY 5 A and Configurable Signal Relay 1 A

Package: 1 Smart Relay, 1 Plastic pin to setup Programming Mode, 1 DIN rail mounting clip with screws, 1 BLE remote module with 3 meters cable, 1 Installation guide (EN/IT)

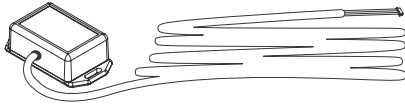
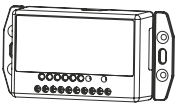

EXTERNAL BLUETOOTH SMART 5.0 (MAX3 METERS)

IS5E065502



x1R Smart 2.0



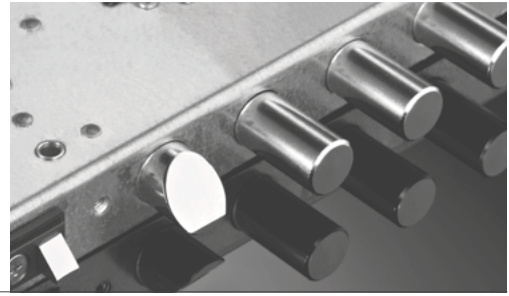

x1R Smart 2.0

x1R SMART is a motorised electronic lock specifically designed for security doors. It combines the solidity of a mechanical lock with the versatility of electronic control via smartphone, RFID tag or keypad.

Key points

Opening occurs with the aid of a motor or the "Single Action" quick release and closing occurs through motorised action controlled by a next-generation microprocessor. In case of lack of power supply the operation of the deadbolt is guaranteed by the traditional movement of keys, equipped with a security system that is able to disconnect motorisation during operation of the mechanical cylinder.

Locks of the x1R Smart series are interchangeable with the most common mechanical locks as they use the same mechanical accessories. The electronic accessories' "plug and play" electrical connections make installation extremely easy.

The system is managed through Iseo Argo, an app available on iOS and Android which you can use to connect your smartphone via Bluetooth Smart 5.0 and manage all functions.

It can be interfaced with the Iseo access control platform or a third-party system through opto-isolated Input/Output connections which can be used to control the operation modes and states for opening and closing. By using the lockbus connection with proprietary protocol it is possible to have a direct and secure connection with the Iseo range devices.

All models are available with different projections and bolt centre-to-centre distances for a vast interchangeability with mechanical versions. Escutcheons are available in various finishes.

Thanks to the solidity of the mechanical structure it is classified at the maximum grade (7) for anti-intrusion protection (EN12209).



It is certified

x1R Smart has been designed and manufactured in compliance with European standards EN14846:2008 with the following classification:



in the Simple Action version it is also certified EN 179: 2008 with the following classification:



Main functions

- Smart device with Bluetooth Smart 5.0 radio interface.
- Opening and programming via Argo App on iOS and Android devices.
- Motorised opening and closing of deadbolts and latchbolt
- Quick opening from inside the room with "Single Action" handle (optional)
- Opening via PIN code, RFID Credentials 13.56 Mhz (ISO 14443A and 14443B), Classic Mifare, Plus, Desfire
- Opening via European profile cylinder (EN1303, DIN 18252)
- Battery powered low-energy consumption device (optional)
- Wake up upon RFID card detection (patented)
- Battery charge status detection
- Light and sound signals
- Hold open function (office function) without extra energy consumption
- Light function (latch only) programmable by the user for certain days and time slots
- Real Time Clock/Calendar
- Memory storage of 300 users
- Memory of the last 1000 events
- Software that can be update by the user in the field
- Compatible with the main mechanical locks for security doors

x1R Smart 2.0

Code

Mortice version

Motorised electronic lock with European profile cylinder.
 Deadbolts in chrome-plated steel \varnothing 18 mm, projection 30 mm
 Reversible latch \varnothing 20 mm, adjustable projection.
 Handle follower 8 mm for latchbolt operation.
 Top and bottom attachments for rods for additional closures.
 Mortice fixing with front plate in chrome-plated steel mm 410x35x3.
 Set up for M6 passing screws for cylinder protection fixing.
 Reversible door sensor with adjustable projection, including alignment device.
 Supplied with: lock, door sensor, cylinder fixing screws, assembly instructions.
 Compatible with Bluetooth 5.0 Smart readers only.

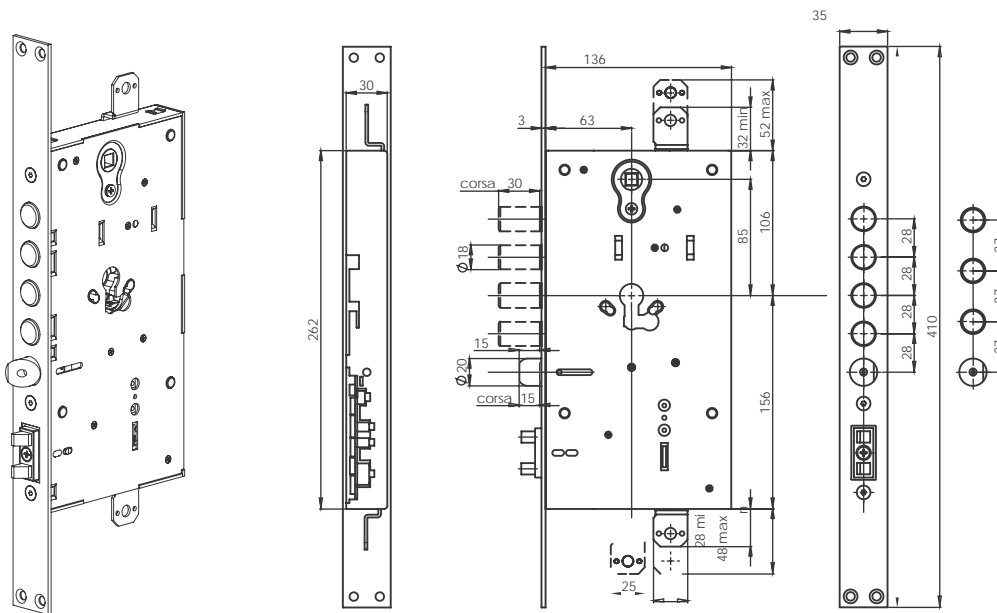

Smart

4 DEADBOLTS. Centre distance 28
 3 DEADBOLTS. Centre distance 37

IS0006960028550
IS0006960037550

Smart SINGLE ACTION with quick release via the handle

4 DEADBOLTS. Centre distance 28
 3 DEADBOLTS. Centre distance 37

IS0006990028550
IS0006990037550

x1R Smart 2.0 Readers

Code



EXTERNAL CONTROL MODULE WITH RFID READER 13.56 MHZ AND BLUETOOTH SMART 5.0

Compatible with x1R SMART, includes pair of connection cables L 100 cm

EXTERNAL CONTROL MODULE WITH RFID READER 13.56 MHZ AND BLUETOOTH SMART 5.0

IS00000098105696



EXTERNAL CONTROL MODULE WITH KEYBOARD,

RFID READER 13,56 MHZ AND BLUETOOTH SMART 5.0 LE compatible with x1R SMART

includes pair of connection cables L 100 cm

EXTERNAL CONTROL MODULE WITH KEYBOARD

IS00000098111696

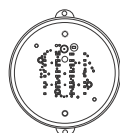

Hidden RFID reader and BLUETOOTH SMART 5.0. Compatible with x1R Smart

Hidden RFID reader and BLUETOOTH SMART 5.0. Compatible with x1R Smart

IS00000098106696



MULTI-READER

Compatible with x1R SMART.

Includes black cover and 3 connection cables L 1 mt.

Numeric keyboard, RFID reader 13,56 Mhz, Bluetooth SMART 5.0

MULTI-READER

IS00000098108696



MULTI-READER WITH FINGERPRINT

Compatible with x1R SMART.

Includes black cover and 3 connection cables L 1 mt.

Numeric keyboard, RFID reader 13,56 Mhz, biometric reader, Bluetooth SMART 5.0

MULTI-READER WITH FINGERPRINT

IS00000098109696

x1R Smart 2.0 Accessories

Code



2-BUTTON INTERNAL CONTROL MODULE
Compatible with x1R SMART, includes connection cable L 60 cm.

X1R Smart 2-BUTTON INTERNAL CONTROL MODULE

IS00000098PI0696

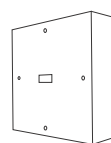

METAL BOX FOR HIDDEN READER
METAL BOX FOR HIDDEN READER

IS00000098NBM696

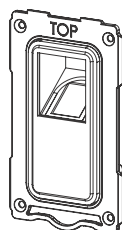

EMBEDDED FLUSH FINGERPRINT READER
Compatible with x1R SMART. Includes pair of connection cables L 100 cm
Encrypted data communication protocol.

EMBEDDED FLUSH FINGERPRINT READER

IS5E62100

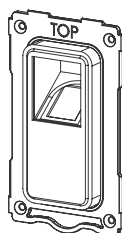

EMBEDDED PROTRUDING FINGERPRINT READER
Compatible with x1R SMART. Includes pair of connection cables L 100 cm
Encrypted data communication protocol.

EMBEDDED PROTRUDING FINGERPRINT READER

IS5E63100

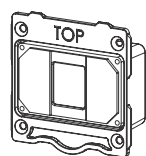

SURFACE MOUNTED FINGERPRINT READER
Compatible with x1R SMART. Includes pair of connection cables L 100 cm
Encrypted data communication protocol.

SURFACE MOUNTED FINGERPRINT READER

IS5E62200

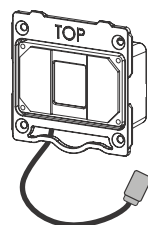

IP66 SURFACE MOUNTED FINGERPRINT READER
Compatible with x1R SMART with embedded cable and IP66 connector.
Encrypted data communication protocol.

IP66 SURFACE MOUNTED FINGERPRINT READER

IS5E62220

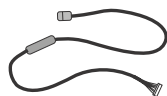

IP66 CABLE FOR FINGERPRINT READER L 1.2 mt.

IP66 CABLE FOR FINGERPRINT READER L 1.2 mt.

IS0000IS00246



IP66 CABLE FOR FINGERPRINT READER L 10 mt.

IP66 CABLE FOR FINGERPRINT READER L 10 mt.

IS0000IS00247

TERMS & CONDITIONS

1. This price list cancels all previous price lists.
2. Prices charged will be those ruling at date of dispatch of goods.
3. Carriage paid order minimum £100.00 at nett invoice value.
4. For orders under £100.00 nett invoice value a carriage charge of £6.50 will apply. For Saturday delivery there is an additional special service carriage charge of £25.00. Requests for direct to site deliveries cannot be accommodated unless authorised by M. Marcus Ltd and if agreed carry an additional charge of £12.00.
5. A. Northern Ireland: For all orders to Northern Ireland that are under £300.00 nett invoice value a carriage charge of £22.00 will apply.
B. Republic of Ireland: For the Republic of Ireland, for orders under £300.00 net invoice value there is a carriage charge of £22.00. Carriage paid on orders above £300.00, however, please note, there will be a customs clearance charge of £25.00 applicable to all orders.
C. In the case of the Channel Islands, the Scottish Highlands / Islands, and the Isle of Man, for orders under £300.00 net invoice value there is a carriage charge of £22.00.
6. For reasons of security, M. Marcus Ltd products cannot normally be delivered direct to site or third-party address. All Items will only be delivered to the trade premises of M. Marcus Ltd account holders only.
7. Payment Terms: 30 days nett.
8. To guarantee receipt of any stocked item for delivery by 12.00 noon next working day, customer orders must be placed before 12.00 noon and are subject to a £22.00 charge. (In the case of Iseo security cylinders which are master keyed or keyed alike then orders are normally dispatched within 5 working days where possible)
9. Shortages must be notified to M. Marcus Ltd within 3 days of receipt of a consignment otherwise no claims can be entertained.
10. Returns: Strictly no returns will be accepted without prior written agreement. Unauthorized returns will be refused and those agreed may be subject to a minimum restocking charge of up to 40%.
It is the responsibility of M. Marcus Ltd account holders to ensure that the correct product codes and descriptions are quoted/used when placing orders with our sales office. Failure to do so may result in the implementation of the full restocking charge for incorrectly ordered items. (Returns procedure applies, please contact the M. Marcus sales office for information).
11. Any order or balance cancellation will ONLY be accepted by fax or email.
12. Any Item which is deemed as a "special order" cannot be cancelled unless agreed otherwise in writing by M. Marcus Ltd. (A special order may be large volumes of a stock line, or an order for a non-standard stock line)
13. All goods invoiced remain the property of M. Marcus Ltd until paid for in full.
14. Due to a continuous programme of development, M. Marcus Ltd., reserves the right to make alterations without notice.
15. For technical reasons connected with colour reproduction the colours shown in this catalogue may vary slightly from those of the product.
16. All dimensions provided are for guidance only.
17. Use of all M. Marcus Ltd images on the website: - Images cannot be reproduced without the express written consent of M. Marcus Ltd.
Pursuant to The Advertising Standards Authority issued ruling as of the 1st of March 2011 regarding website marketing and advertising – please refer to www.asa.org.uk for "The CAP Code" to ensure you are not in breach of any regulations.



presented by



m. marcus
est. 1940

M. Marcus Limited
Unit 7, Narrowboat Way,
Dudley, West Midlands,
DY2 0XQ, England

Tel: 01384 457900
Fax: 01384 253687

iseosales@m-marcus.com

Web: www.m-marcus.com